



深圳永亿豪电子有限公司

APPROVAL SHEET

Customer:

Customer P/N:

SNOWFAN Model NO.: YY25489H24B

SNOWFAN P/N:

Version.: 1 Sample NO.:

Issue date: Quantity: 0 PCS

***Please sign back this specification for our record upon your approval. Thanks!**

Company Stamp

制作: 程 梅
复核: 曾睿君 何果
核准:

Customer approval Stamp

承认:
核准:
日期:

地址: 深圳市龙华新区观澜街道福民茜坑新村佰公坳工业区二巷 10 号厂房

电话: 28035708 传真: 28035808

<http://www.snowfan.com.cn/>

E-Mail: yongyihao@snowfan.com.cn

1.0 一般规格 (General Specification)

项目 Item		规格/条件 Specification/Condition	
1	型号 Model No.	YY25489H24B	
2	外型尺寸 Outline. Dimension	254*89mm	
3	工作电压 Operating Voltage	DC 18-26.5V	
4	额定电压 Rated .voltage	DC 24V	
5	启动电压 Starting Voltage	DC ≤18V on/off	
6	额定电流 Rated current	2.1A (MAX: 8.5A)	a. 额定电压 Rated .voltage b. 25°C 65% RH c. After testing for 5 minutes
7	消耗功率 Power consumption	50.4W (MAX: 204W)	
8	转速 Speed	2500±10%RPM	
9	风量 Airflow AT ZERO STATIC PRESSURE	718CFM (Min: 646CFM)	a. 额定电压 Rated .voltage b. AMCA 标准 Standard C. 额定电流 Rated current
	静压 Air .Static Pressure AT ZERO AIRFLOW	25.5mmH2O (Min. : 22.95mmH2O)	
10	噪音标准 Noise Level	68.2dB-A (Max: 75.7dB-A)	a. 额定电压 Rated Voltage b. 18dB无响室 (18dB Non-Echo Chamber) c. 标准 Standard: CNS 8753 / ISO 3744 d. Test Condition : ISO 7779 e. 距离 Distance: 1.0 M
11	期望寿命 Life expectancy	50000 hrs at temp40°C Humidity5%-95%	MTTF Mean Time To Failure Conf. Level 90%
12	扇叶数 No. of. Blade	3 叶	
13	极数 No. of. Pole	8 极	
14	运转方向 Rotating Direction	逆时针/运转方向是从标签面看	
15	锁住保护 Lock Protection	1. 额定电压堵住2-3秒 自动断电 降低内部温升 Auto power off after locked at rated voltage for 2-3 sec. Reduce internal temperature rise 2. 自动断电后, 2至6秒自动尝试启动 After auto power off, circuit attempt to restart in 2 to 6 sec.	
16	极性保护 Polarity Protection	Vcc与GND反接时 不导通 Open circuit when Vcc & GND are exchanged	
17	过流保护 Over current protection	有 YES	
18	恒速功能 fixed constant speed Function	该风扇电机的程序可以运行在一个预先设定的转速, 超过设定电压, 而其速度保持不变, 最大电源电压要在工作范围内 The fan motor can be run at a predetermined speed, exceeds the set voltage, and its speed is constant, the maximum supply voltage to be within the scope of work in	
19	软启动 Soft Starting	当给风扇供电, 风扇的电流是从零开始逐渐增加, 直到达到其最高转速和额定电流 When the power switch is turned on to supply current to the fan, the current is zero and starts to increase gradually until the fan has achieved its maximum speed and the rated current.	
20	PWM 功能 PWM function	通过输入一个PWM占空比信号控制风扇运转方向 Enter a PWM duty cycle signal to control fan Rotating Direction	
21	PQ 曲线 PQ curve		

2.0 主要材料/零件规格 (Main Materials/parts Specification)

材料/零件 Materials/parts		规格 Specification			
1	塑料材料/ 外框扇叶 Plastic Material/ Frame impeller	黑色铝圆框 PBT 3 叶			
2	轴承 Bearing Type	滚珠轴承 Ball Bearing			
3	引线 Lead Wire	UL1007#20#红黑蓝黄分线+100mm 黑色套管			
4	端子 Connector	2.54 白色反端-4P			
		红	黑	蓝	黄
		VCC	GND	PWM	FG
5	环保要求 Environmental Requirement	<input checked="" type="checkbox"/> ROHS	<input type="checkbox"/> 无卤	<input checked="" type="checkbox"/> 永亿豪环保标准	<input type="checkbox"/> REACH

3.0 电性规格 (Electrical Specifically)

1	绝缘阻抗 Insulation Resistance	10MΩ /裸线 与外框间测量, 500VDC/min 10MΩ /between unshackled wire and frame at 500VDC/min
2	绝缘耐压 Dielectric Strength	5Ma Max./导线 与外框间测量, 500VAC/min 5Ma Max./Measured between lead wire(+)and frame at 500VAC/min
3	防水等级 Waterproof level	IP X0

4.0 环境测试 (Environmental Specification)

1	运转温/湿度范围 Operating Temp . Range	温度/Temperature:-10℃ - +70℃ 湿度/Humidity:5% - 95%RH
2	保存温/湿度范围 Storage Temperature	温度/Temperature:-40℃ - +75℃ 湿度/Humidity:5% - 95%RH
3	耐湿性 Humidity	电气规格依据 MIL-STD 202F Method 103B 湿度: 95%RH 温度: 40±2℃
4	热冲击 Thermal Shock	电气规格依据 MIL-STD 202F Method 107D Per MIL-STD 202F Method 107D,Condition D
5	绝缘阶段 Insulation Shock	UL: A 级 UL: Class A
6	包装耐振动试验 Packing Vibration Test	包装后, XYZ 三方向施 1.1G load vibration test for 30min.No serious damage
7	包装耐冲击试验 Packing Shock Proof Test	捆包后, 高 60 公分, 1 棱角 3 边 6 面自然落下, 无严重损坏。 1corner, 3edges, 6faces natural drop from 60cm high packing No serious damage

5.0 在无响室额定电压下之噪音测试

(Noise is measured at rated voltage in anechoic)

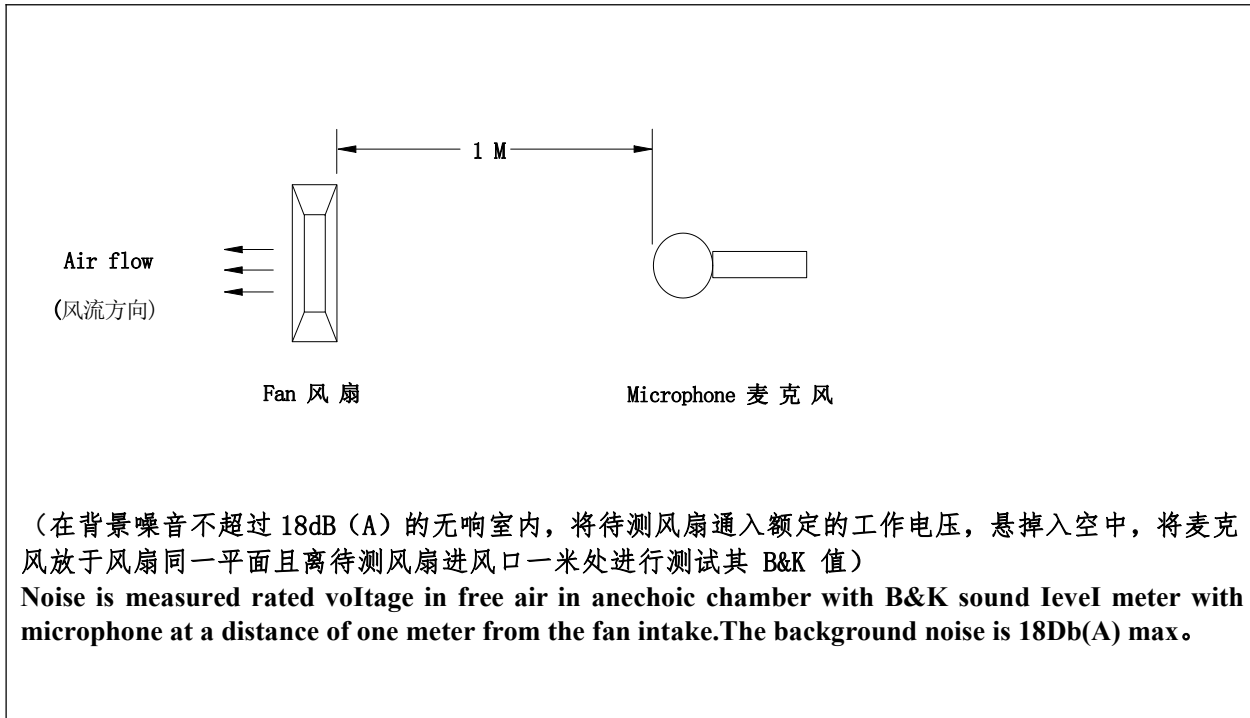

✦ Function type is optional.

6.0 信号及波形 (Frequency Generator 0/P)

6.1 信号测试方式 (Frequency test mode)

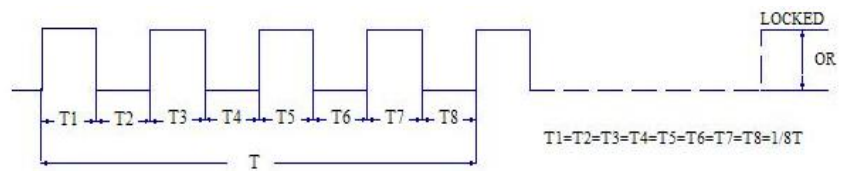
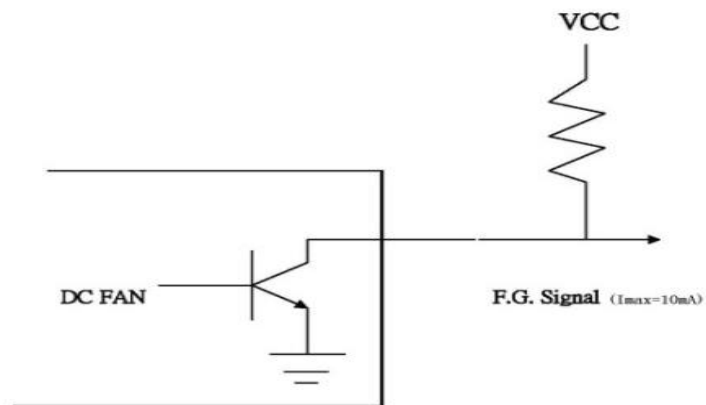

7.0 PWM 信号 (PWM Signal)

7.1 PWM 输入电路

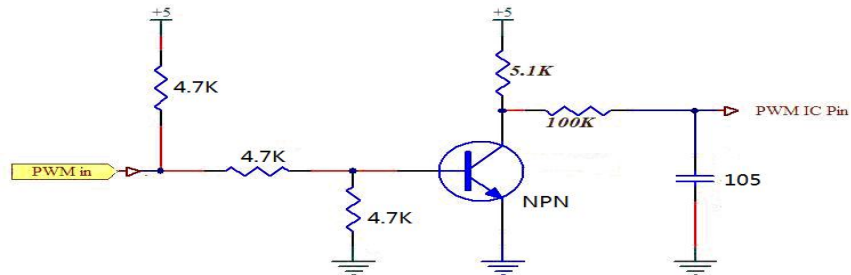

7.2 PWM 输入信号

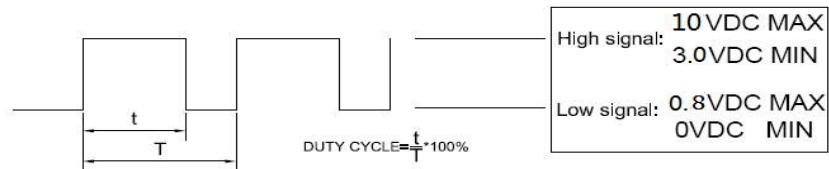

The frequency to accept 300Hz to 30KHz

7.3 转速与 PWM 控制信号(Speed VS PWM control signal) (At 24V T=25°C)

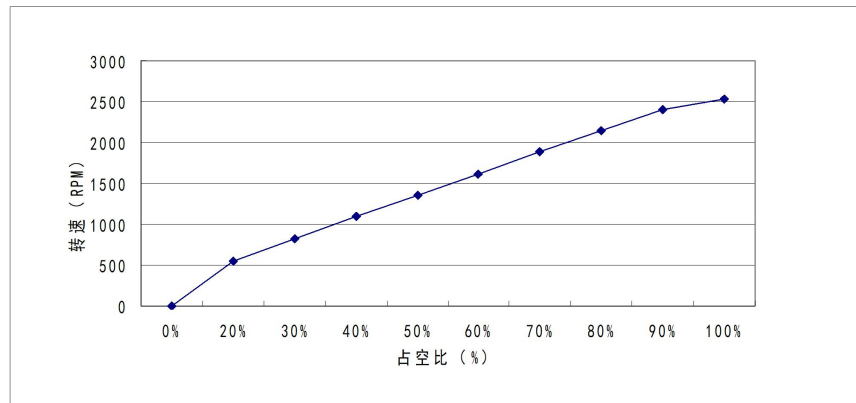

占空比调速 (PWM)	0%	20%	50%	100%
转速 (RPM)	停转	550 ± 200RPM	1360 ± 200RPM	2500 ± 10%RPM

版本	内容	日期	核准
A	新版发行	2015.08.27	陈卿伟

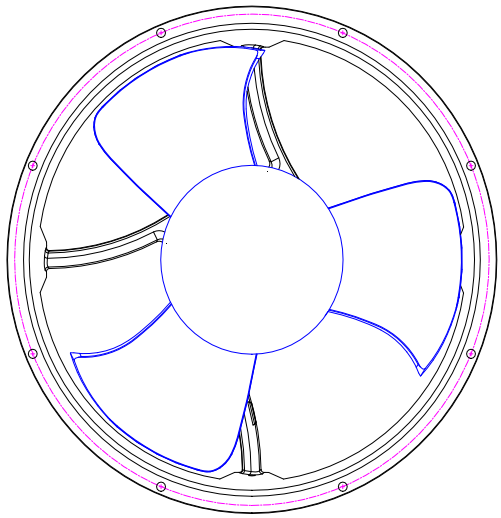
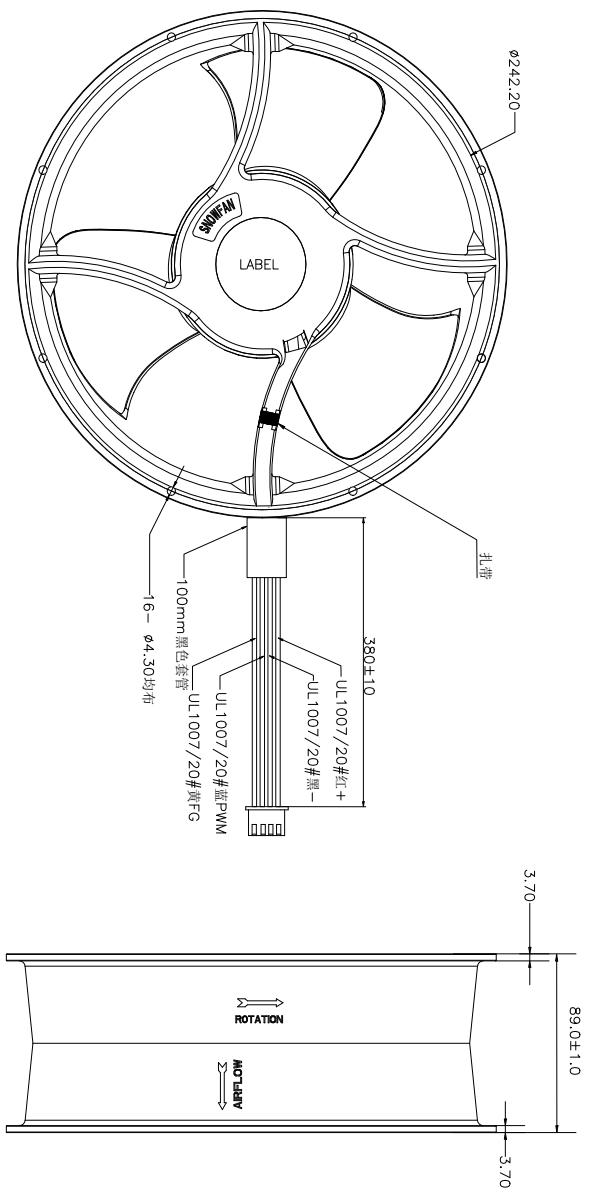

产品名称/规格		25489-双B风扇	
X.XX ±0.05	图号:1508196	绘制:程梅	审核:陈卿伟
X.X ±0.1	日期:2015.08.27	比例:None	页次:1/1
XXX.X ±0.2	单位:mm	版次:AO	核准:肖雪生
XXXX.X ±0.5			

SNOWFAN 深圳市永亿豪电子有限公司

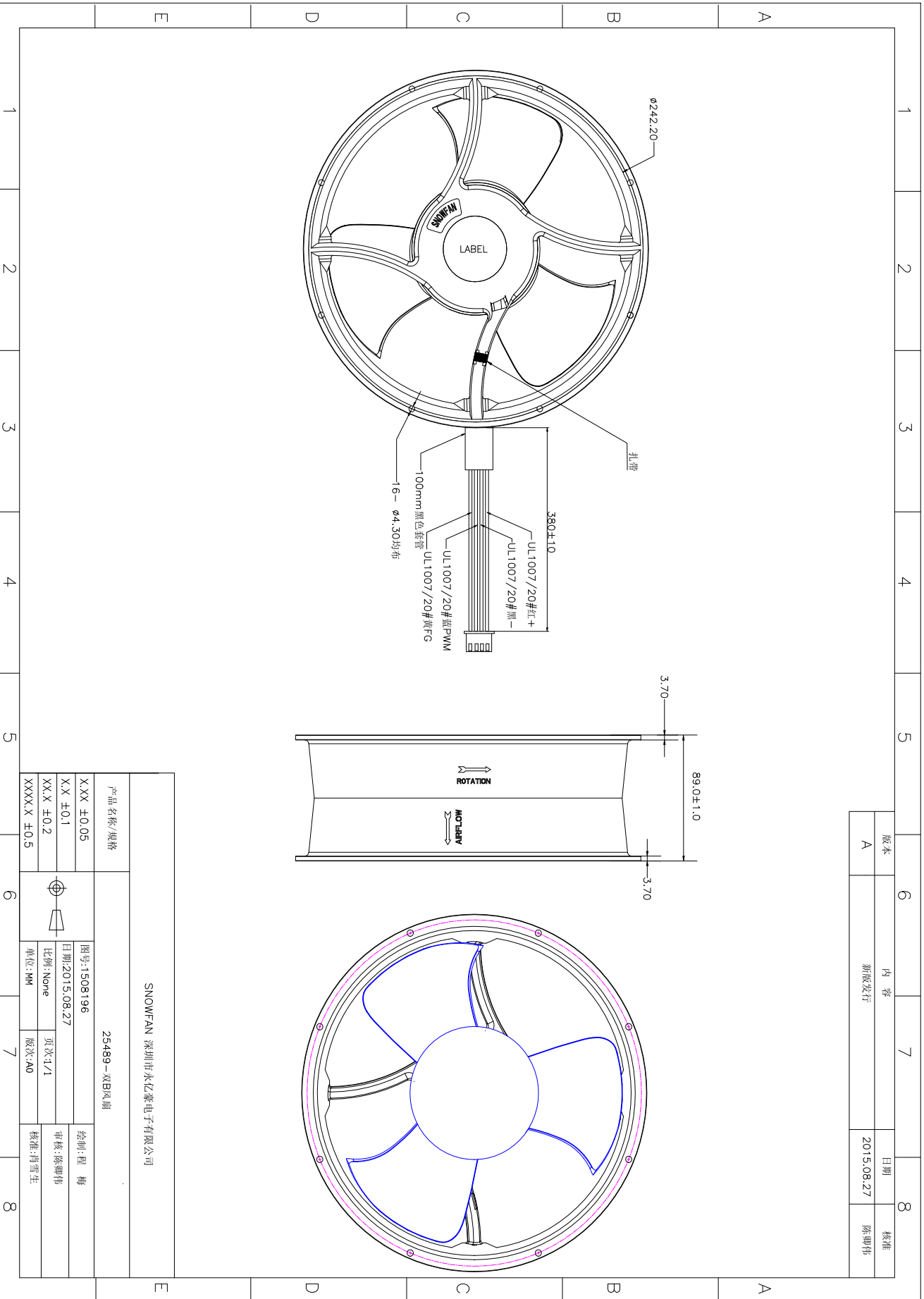

注意事项 (NOTES)

1 Before use, make sure the supply voltage to meet the use of the product range, line-powered load exceeds the maximum power consumption of this product 120%. And the voltage is stable without clutter

(使用前, 确认供电电压能满足本产品的使用范围, 供电电路负载超过本产品的最大功耗的 120%。且电压是稳定不含杂波干扰)

2 Please when ventilator circular telegram normal work do not use the hand to bump touches fan blade border

(请在风扇通电正常运转时不要用手碰触扇叶边沿)

3 Please do not touch the impeller and never carry the fan the lead wires. The bearings and the lead wires may be damaged. Additionally, static electricity may damage the intemal ciruits of the fan

(请不要碰触扇叶和拉扯线材, 以免损坏轴承及导线。此外, 静电可能损坏内部的风扇组件)

4 Please do not use the fan in the environment of corrosive gas or liquid.

(请不要将风扇置于腐蚀的气体和液体内)

5 Please do not store the an in the environmet of high humidity. Please avoid storage of the fan over 6months. For long term storage, please connect power to the fan shortly every 6 months even through the fan is stored in room temperature.

(请不要将风扇储存在高湿度的环境中, 请尽量避免将风扇储存期超过 6 个月。如果要长期储存, 请将其在室温的环境下。且每隔 6 个月须上电源让风扇短时间运转。)



Shenzhen Tian Hai Test Technology Co.,Ltd.

CE Certificate of Conformity

Certification number: TH15CC-164S

Report number: TH15CR-164S

Shenzhen Tian Hai Test Technology Co.,Ltd. hereby declares that testing has been completed and reports have been generated for:

Applicant: **Shen zhen Yong yi hao Electronic co.,LTD**
Address: Industrial Distrial. Niu e Ling Village Guan lan Town, Bao An District, Shen zhen City, Guang dong Province, China
Manufacturer: **Shen zhen Yong yi hao Electronic co.,LTD**
Address: Industrial Distrial. Niu e Ling Village Guan lan Town, Bao An District, Shen zhen City, Guang dong Province, China
Product: **DC fan**
Model: See attachment
Rating: DC5-48V 10.5Amax
Note: All models share same circuit diagram, just with different current and size. All test performance on:YY9238X48Y&YY8038X48Y

And, in accordance with the following applicable directives:

2014 / 35 / EU Low Voltage Directive

That this product has been assessed against the following applicable standards:

Standard EN 60950-1:2006/A2:2013

Therefore, Shenzhen Tian Hai Test Technology Co.,Ltd. hereby acknowledges that the applicant may issue a DECLARATION of CONFORMITY and apply the CE marking in accordance with European Union Rules.

Attestation by:

Thomas Wong



FL.1, No.2 BLDG, Yalian Highstar Industrial Zone, Wuhe Road No. 5022, Bantian street, Longgang District, Shenzhen

Tel:+86-755-86615100

Fax:+86-755-86615105

<http://www.tianhaitest.com>

CERTIFICATE

No. B 15 04 90231 003



Product Service

Holder of Certificate: Shenzhenshi Yongyihao
Electronic Co., Ltd.

No. 155-1 Niuling District
Jinlonghu District, Guanlan St, Bao'an Town
518000 Shenzhen, Guangdong
PEOPLE'S REPUBLIC OF CHINA



Certification Mark:



Product:

**Fan
(DC FAN)**

The product was tested on a voluntary basis and complies with the essential requirements. The certification mark shown above can be affixed on the product. It is not permitted to alter the certification mark in any way. In addition the certification holder must not transfer the certificate to third parties. See also notes overleaf.

Test report no.: 682101424502

Valid until: 2020-04-06

Date, 2015-04-07

Page 1 of 16

(Yager Bi)

