



深圳市永亿豪电子有限公司

APPROVAL SHEET

Customer:

Customer P/N:

SNOWFAN Model NO.: YY14025H24B

SNOWFAN P/N: G1409432B

Version.: 0 Sample NO.:

Issue date: 2019-8-28 Quantity: 0 PCS

***Please sign back this specification for our record upon your approval. Thanks!**

Company Stamp

制作: 程 梅
复核: 刘国泰
核准:

Customer Approval Stamp

承认:
核准:
日期:

地址: 深圳市龙华新区观澜街道福民茜坑新村佰公坳工业区二巷 10 号厂房

电话: 28035708 传真: 28035808

<http://www.snowfan.com.cn/>

E-Mail: yongyihao@snowfan.com.cn

版次	变更履历	日期
A	新版发行	2019.8.28

1.0: 一般规格 (General Specification)

项目 Item		规格/条件 Specification/Condition																			
1	型号 Model No.	YY14025H24B																			
2	外型尺寸 Outline. Dimension	140*140*25mm																			
3	工作电压 Operating Voltage	DC 14 ~ 27.6V																			
4	额定电压 Rated .voltage	DC 24V																			
5	启动电压 Starting Voltage	DC ≤14V on/off																			
6	额定电流 Rated current	0.24A(Max:0.52A)	a. 额定电压 Rated .voltage b.25°C 65% RH c.After testing for 5 minutes																		
7	消耗功率 Power consumption	5.76W(Max:12.48W)																			
8	转速 Speed	2500±10%RPM																			
9	风量 Airflow AT ZERO STATIC PRESSURE	127.33CFM(Min: 114.59CFM)	a. 额定电压 Rated .voltage b. AMCA 标准 Standard C. 额定电流 Rated current																		
	静压 Air .Static Pressure AT ZERO AIRFLOW	3.86mmH2O (Min: 3.47mmH2O)																			
10	噪音标准 Noise Level	46.5dB-A(Max:51.1dB-A)	a. 额定电压 Rated Voltage b. 18dB无响室 18dB Non-Echo Chamber c. 标准 Standard: CNS 8753 / ISO 3744 d. Test Condition :ISO 7779 e. 距离 Distance: 1.0 M																		
11	期望寿命 Life expectancy	70000 hrs at temp40°C Humidity5% ~ 95%	MTTF (Mean Time To Failure Conf. Level 90%																		
12	扇叶数 No.of.Blade	7 叶																			
13	极数 No.of.Pole	4 极																			
14	运转方向 Rotating Direction	顺时针/运转方向是从标签面看																			
15	锁住保护 Lock Protection	1.额定电压下堵住2~3秒,风扇自动断电,停止运转,降低内部温升 Auto power off after locked at rated voltage for 2 ~ 3 sec. Reduce internal temperature rise 2.风扇停转后,风扇会在2至6秒自动尝试启动 After auto power off, circuit attempt to restart in 2 to 6 sec.																			
16	极性保护 Polarity Protection	VCC与GND反接时 不导通 Open circuit when Vcc & GND are exchanged																			
17	过压保护 Over voltage protelt	无 NO																			
18	过流保护 Over current protection	有 YES																			
19	恒速功能 fixed constant speed Function	该风扇电机的程序可以运行在一个预先设定的转速 超过设定电压 而其速度保持不变 最大电源电压要在工作范围内 The fan motor can be run at a predetermined speed, exceeds the set voltage, and its speed is constant, the maximum supply voltage to be within the scope of work in																			
20	软启动 Soft Starting	当给风扇供电,风扇的电流是从零开始逐渐增加 直到达到其最高转速和额定电流 When the power switch is turned on to supply current to the fan, the current is zero and starts to increase gradually until the fan has achieved its maximum speed and the rated current																			
21	PWM 功能 PWM function	通过输入一个PWM占空比信号控制风扇转速. Enter a PWM duty cycle signal to control fan speed																			
22	PQ 曲线 PQ curve	<p>P-Q曲线Performance Curve</p> <table border="1"> <caption>P-Q Performance Curve Data</caption> <thead> <tr> <th>Air Flow (CFM)</th> <th>Air Pressure (mmH2O)</th> </tr> </thead> <tbody> <tr><td>0</td><td>4.0</td></tr> <tr><td>20</td><td>3.5</td></tr> <tr><td>40</td><td>3.0</td></tr> <tr><td>60</td><td>2.5</td></tr> <tr><td>80</td><td>2.0</td></tr> <tr><td>100</td><td>1.5</td></tr> <tr><td>120</td><td>1.0</td></tr> <tr><td>140</td><td>0.5</td></tr> </tbody> </table>		Air Flow (CFM)	Air Pressure (mmH2O)	0	4.0	20	3.5	40	3.0	60	2.5	80	2.0	100	1.5	120	1.0	140	0.5
Air Flow (CFM)	Air Pressure (mmH2O)																				
0	4.0																				
20	3.5																				
40	3.0																				
60	2.5																				
80	2.0																				
100	1.5																				
120	1.0																				
140	0.5																				

2.0:主要材料/零件规格 (Main Materials/parts Specification)

材料/零件 Materials/parts		规格 Specification			
1	塑料材料/扇叶 外框 Plastic Material/ Frame impeller	扇框: PBT 黑色方框 环保防火 防火等级: 94V-0			
		扇叶: PBT 黑色 7 叶 环保防火 防火等级: 94V-0			
2	轴承 Bearing Type	滚珠轴承 Ball Bearing			
3	引线 Lead Wire	UL1007#24#黑红黄蓝分线			
4	端子 Connector	无端-4P			
		黑	红	黄	蓝
		GND	VCC	FG	PWM
5	环保要求 Environmental Requirement	<input checked="" type="checkbox"/> ROHS	<input checked="" type="checkbox"/> 永亿豪环保标准	<input type="checkbox"/> 无卤	<input type="checkbox"/> REACH

3.0 电性规格 (Electrical Specifically)

1	绝缘阻抗 Insulation Resistance	10MΩ/裸线与外框间测量, 500VDC/min 10MΩ/between unshackled wire and frame at 500VDC/min
2	绝缘耐压 Dielectric Strength	5Ma Max./导线与外框间测量, 500VAC/min 5Ma Max./Measured between lead wire(+)and frame at 500VAC/min
3	防水等级 Waterproof level	IP XO

4.0 环境测试 (Environmental Specification)

1	运转温/湿度范围 Operating Temp .Range	温度/Temperature:-10°C ~ +70°C 湿度/Humidity:5% ~ 95%RH
2	保存温/湿度范围 Storage Temperature	温度/Temperature:-40°C ~ +75°C 湿度/Humidity:5% ~ 95%RH
3	耐湿性 Humidity	电气规格依据 MIL-STD 202F Method 103B 湿度: 95%RH 温度: 40±2°C
4	热冲击 Thermal Shock	电气规格依据 MIL-STD 202F Method 107D Per MIL-STD 202F Method 107D,Condition D
5	绝缘阶段 Insulation Shock	UL: A 级 UL: Class A
6	包装耐振动试验 Packing Vibration Test	包装后, XYZ 三方向施 3.2G load vibration test for 30min .No serious damage
7	包装耐冲击试验 Packing Shock Proof Test	捆包后, 高 60 公分, 1 棱角 3 边 6 面自然落下, 无严重损坏. 1corner,3edges, 6faces natural drop from 60cm high packing No serious damage

5.0 在无响室额定电压下之噪音测试

(Noise is measured at rated voltage in anechoic)



✦ Function type is optional.

6.0 信号及波形 (Frequency Generator 0/P)

6.1 信号测试方式 (Frequency test mode)

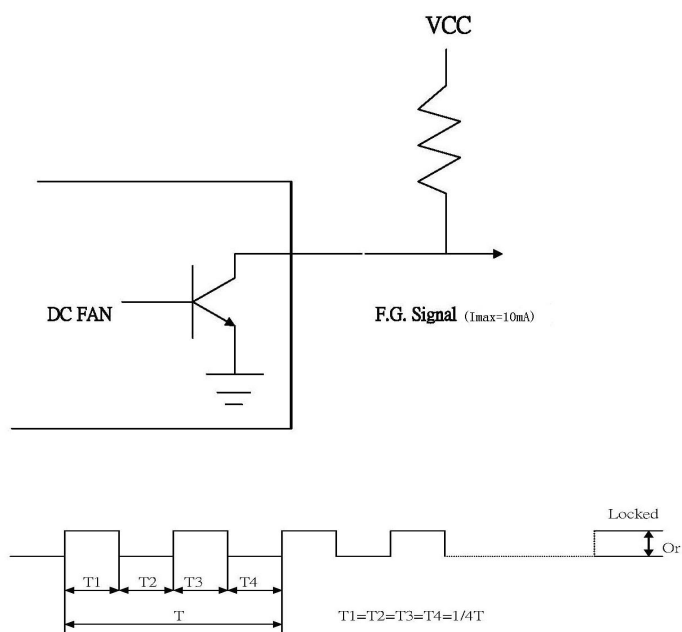

7.0 PWM 信号 (PWM Signal)

7.1 风机 PWM 信号内部接口电路

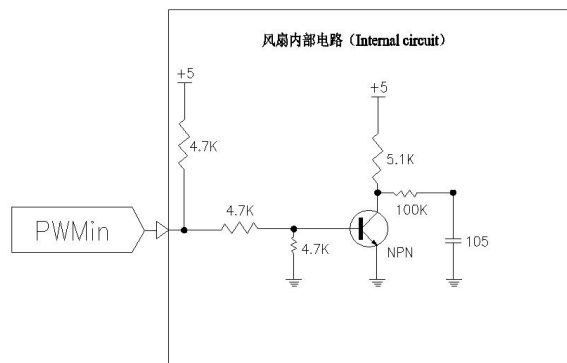

7.2 PWM 输入信号

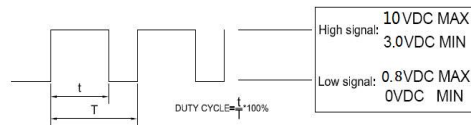

The frequency to accept 300Hz to 30KHz

7.3 转速与 PWM 控制信号(Speed VS PWM control signal) (At 24V T=25°C)

占空比 (%)	0%	10%	50%	100%
转速 (RPM)	0	900±200RPM	1700±200RPM	2500±10%RPM

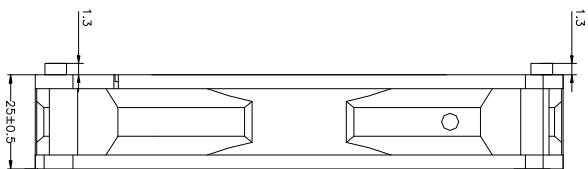
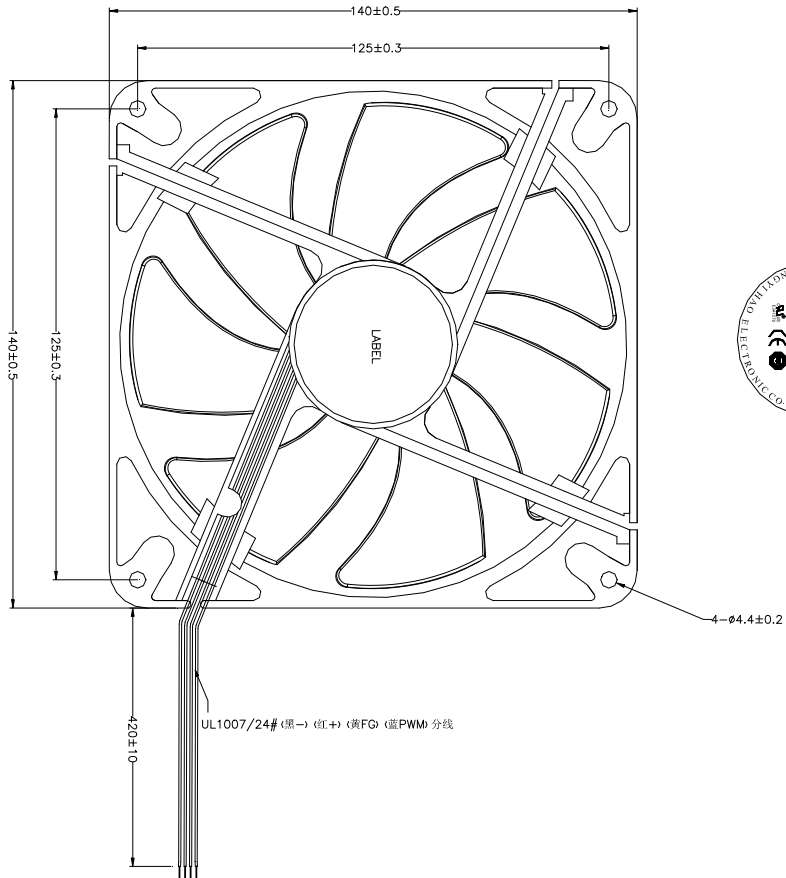
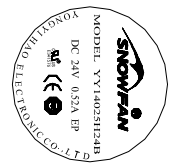

版本	内容	日期	核准
A	新版发行	2019.8.28	杜健

SNOWFAN 深圳市永亿泰电子有限公司

14025-2B风扇

产品名称/规格		图号:G14094.33B		绘制/程 梅	
XX 4.0.05		日期:2019.8.28		审核:陈公平	
XX 4.0.1		比例:1:1		单位:mm	
XX X 4.0.2		图次:01		核准:杜 健	
XXXX 4.0.5					

注意事项 (NOTES)

1 Before use, make sure the supply voltage to meet the use of the product range, line-powered load exceeds the maximum power consumption of this product 120%.

And the voltage is stable without clutter

(使用前, 确认供电电压能满足本产品的使用范围, 供电电路负载超过本产品的最大功耗的 120%。且电压是稳定不含杂波干扰)

2 Please when ventilator circular telegram normal work do not use the hand to bump touches fan blade border

(请在风扇通电正常运转时不要用手碰触扇叶边沿)

3 Please do not touch the impeller and never carry the fan the lead wires. The bearings and the lead wires may be damaged. Additionally, static electricity may damage the intemal ciruits of the fan

(请不要碰触扇叶和拉扯线材, 以免损坏轴承及导线。此外, 静电可能损坏内部的风扇组件)

4 Please do not use the fan in the environment of corrosive gas or liquid.

(请不要将风扇置于腐蚀的气体和液体内)

5 Please do not store the an in the environmet of high humidity. Please avoid storage of the fan over 6months. For long term storage, please connect power to the fan shortly every 6 months even through the fan is stored in room temperature.

(请不要将风扇储存在高湿度的环境中, 请尽量避免将风扇储存期超过 6 个月。如果要长期储存, 请将其在室温的环境下。且每隔 6 个月须上电源让风扇短时间运转。)



Shenzhen Tian Hai Test Technology Co.,Ltd.

CE Certificate of Conformity

Certification number: TH15CC-164S

Report number: TH15CR-164S

Shenzhen Tian Hai Test Technology Co.,Ltd. hereby declares that testing has been completed and reports have been generated for:

Applicant: Shen zhen Yong yi hao Electronic co.,LTD
Address: Industrial Distrial. Niu e Ling Village Guan lan Town, Bao An District, Shen zhen City, Guang dong Province, China
Manufacturer: Shen zhen Yong yi hao Electronic co.,LTD
Address: Industrial Distrial. Niu e Ling Village Guan lan Town, Bao An District, Shen zhen City, Guang dong Province, China
Product: DC fan
Model: See attachment
Rating: DC5-48V 10.5Amax
Note: All models share same circuit diagram, just with different current and size.
All test performance on:YY9238X48Y&YY8038X48Y

And, in accordance with the following applicable directives:

2014 / 35 / EU Low Voltage Directive

That this product has been assessed against the following applicable standards:

Standard EN 60950-1:2006/A2:2013

Therefore, Shenzhen Tian Hai Test Technology Co.,Ltd. hereby acknowledges that the applicant may issue a DECLARATION of CONFORMITY and apply the CE marking in accordance with European Union Rules.

Attestation by:

Thomas Wong



FL.1, No.2 BLDG, Yalian Highstar Industrial Zone, Wuhe Road No. 5022, Bantian street, Longgang District, Shenzhen
Tel:+86-755-86615100 Fax:+86-755-86615105 <http://www.tianhaitest.com>

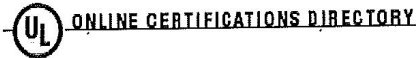

GPWV2.E341576
Fans, Electric - Component

[Page Bottom](#)

Fans, Electric - Component

[See General Information for Fans, Electric - Component](#)

SHENZHEN YONGYIHAO ELECTRONIC CO LTD

E341576

No 155-1 Niueling District
Jinlonghu District
Guanlan St, Bao'an Town
Shenzhen, Guangdong 518000 CHINA

DC fans, Models YY2507(X)05(Y), YY2507(X)12(Y), YY4010(X)05(Y), YY4010(X)12(Y), where (X) may be L, M or H, (Y) may be S, B or SB.

Models YY5010(X)05(Y), YY5010(X)12(Y), YY5015(X)12(Y), YY5020(X)12(Y), YY4020(X)12(Y), YY6025(X)12(Y), YY6020(X)12(Y), YY8015(X)12(Y), YY8020(X)12(Y), YY8025(X)12(Y), YY9225(X)12(Y), YY12025(X)12(Y), YY5015(X)24(Y), YY5020(X)24(Y), YY4020(X)24(Y), YY6025(X)24(Y), YY6020(X)24(Y), YY8015(X)24(Y), YY8020(X)24(Y), YY8025(X)24(Y), YY9225(X)24(Y), YY12025(X)24(Y), YY8038(X)12(Y), YY8038(X)24(Y), YY9238(X)12(Y), YY9238(X)24(Y), where (X) may be H, M or L, (Y) may be S, B or SB.

Models YY3007(X)05(Y), YY3007(X)12(Y), YY3507(X)05(Y), YY3507(X)12(Y), YY2510(X)05(Y), YY2510(X)12(Y), YY3010(X)05(Y), YY3010(X)12(Y), YY3510(X)05(Y), YY3510(X)12(Y), YY4007(X)05(Y), YY4007(X)12(Y), YY7025(X)12(Y), YY7025(X)24(Y), YY12038(X)12(Y), YY12038(X)24(Y), YY12038(X)48(Y), YY17251(X)12(Y), YY17251(X)24(Y), YY17251(X)48(Y), where (X) may be H, M or L, (Y) may be S, B or SB.

AC fans, Models Y8025-A1, Y9225-A1, Y8025-A2, Y9225-A2, Y12025-A1, Y12025-A2, Y8038-A1, Y8038-A2, Y12038-A2, Y17050-A1, Y17050-A2, TY8038-A1, TY8038-A2, TY9238-A1, TY9238-A2, TY12038-A1, TY12038-A2, TY12738-A1, TY12738-A2, TY17055-A1, TY17055-A2, Y17040-A2-C, Y12038-A1-C, Y12038-A2-C, Y14045-A1-C, Y14045-A2-C, Y17050-A1-C, Y17050-A2-C, Y16062-A1-C, Y16062-A2-C, Y18065-A1-C, Y18065-A2-C, Y22060-A1-C, Y22060-A2-C, Y20060-A1-C, Y20060-A2-C, Y2509-A1-C, Y2509-A2-C, TY22580-A1-C, TY22580-A2-C, TY28080-A1-C, YH133-A1, YH133-A2, YH175-A1, YH175-A2, YH190-A1, YH190-A2, YH220-A1, YH220-A2, YD133-A1, YD133-A2, YH225-A1, YH225-A2, YH250-A1, YH250-A2, YH280-A1, YH280-A2, YD140-A1, YD140-A2, YD150-A1, YD150-A2, YD200-A1, YD200-A2, YS133-A1, YS133-A2, YS151-A1, YS151-A2, YS146-A1, YS146-A2, YH320-A1, YH320-A2, YH355-A1, YH355-A2, YH400-A1, YH400-A2, YD180-A1, YD180-A2.

Low voltage component fans, Models YY2006(X)12(Y), YY2010(X)12(Y), YY4015(X)12(Y), YY4510(X)12(Y), YY4028(X)24(Y), YY4028(X)12(Y), YY5020(X)12(Y), YY5025(X)12(Y), YY6010(X)12(Y), YY7010(X)12(Y), YY8010(X)12(Y), YY6038(X)48(Y), YY6038(X)24(Y), YY6038(X)12(Y), YY6015(X)24(Y), YY6015(X)12(Y), YY7015(X)12(Y), YY7020(X)12(Y), YY7530(X)12(Y), YY9225(X)48(Y), YY8025(X)48(Y), YY9232(X)24(Y), YY9232(X)12(Y), YY9733(X)12(Y), YY12032(X)12(Y), YY14025(X)24(Y), YY14025(X)12(Y), where (X) may be H, M or L; (Y) may be S, B or SB.

Low Voltage Component Fans, Models YY25489(X)48(Y), YY133(X)48(Y), YY133(X)24(Y), YY175(X)48(Y), YY175(X)24(Y), YY190(X)48(Y), YY190(X)24(Y), YY225(X)48(Y), YY225(X)24(Y), YY250(X)48(Y), YY250(X)24(Y), YY310(X)48(Y), YY400(X)48(Y), where (X) may be H, M or L; (Y) may be S, B or SB.

Low voltage component fans, Models YY8038H48(Y), YY8038M48(Y), YY8038L48(Y), YY9238H48(Y), YY9238M48(Y), YY9238L48(Y), YY8015H12(Y), where (Y) may be S, B or SB.

Low voltage component fans, Models YY9010H12(Y), YY9010M12(Y), YY9010L12(Y), YY9225H12(Y), YY12032H48(Y), YY12032M48(Y), YY12032L48(Y), YY355H48(Y), YY355M48(Y), YY355L48(Y), where (Y) may be S, B or SB.

Marking: Company name or "E341576" and model designation.

[Last Updated](#) on 2015-06-21

[Questions?](#)

[Print this page](#)

[Terms of Use](#)

[Page Top](#)

◆ 2017 UL LLC

The appearance of a company's name or product in this database does not in itself assure that products so identified have been manufactured under UL's Follow-Up Service. Only those products bearing the UL Mark should be considered to be

<http://database.ul.com/cgi-bin/XYV/template/LISEXT/IFFRAME/showpage.html?name=GPWV2.E341576&ccnshorttitle=Fans,+Electric+--+Component&obji...> 1/2

CERTIFICATE

No. B 16 03 90231 005



Product Service

Holder of Certificate: **Shenzhenshi Yongyihao Electronic Co., Ltd.**

No.10 Lane 2
Bai Gong Ao Industrial Area, Xikeng New Village
Longhua New District
518000 Shenzhen City, Guangdong Province
PEOPLE'S REPUBLIC OF CHINA



Certification Mark:



Product: **Fan
(DC FAN)**

The product was tested on a voluntary basis and complies with the essential requirements. The certification mark shown above can be affixed on the product. It is not permitted to alter the certification mark in any way. In addition the certification holder must not transfer the certificate to third parties. See also notes overleaf.

Test report no.: 682101424503

Valid until: 2021-03-24

Date, 2016-03-29

(Rickyet Wang)

Page 1 of 16

